

**PROCHEMA BAAR AG**



**hi** retail<sup>®</sup>

***Wall System***



# WALL SYSTEM

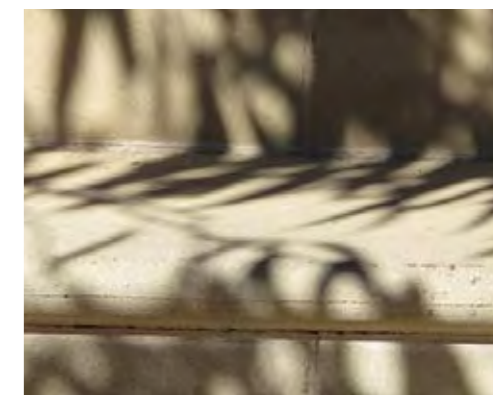
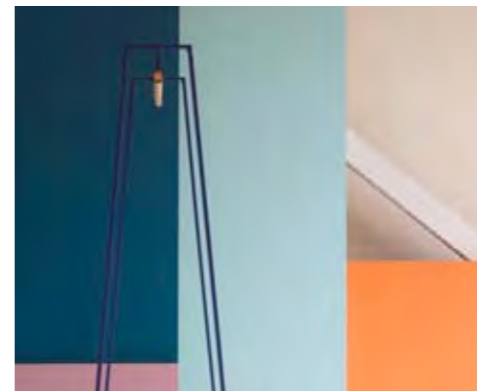
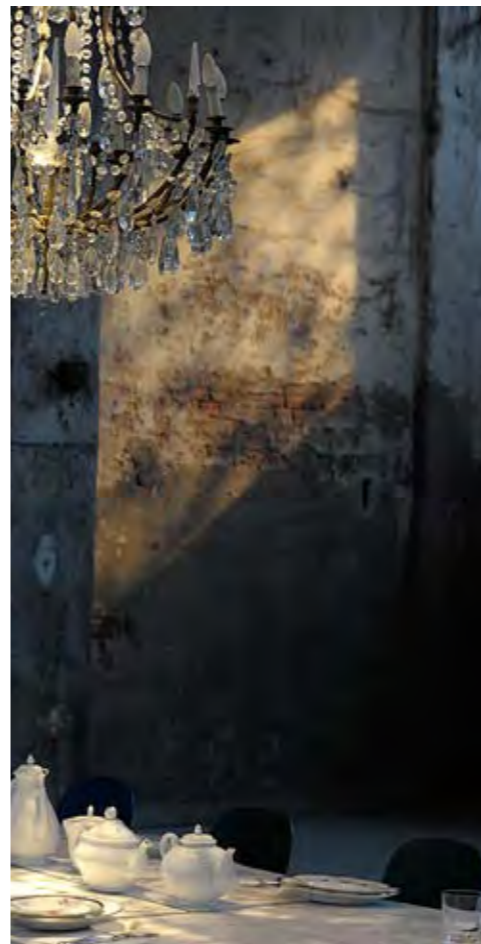



*Montanti a parete con sistema a cremagliera*  
*Wall uprights with rack system*

La collezione Wall System racchiude tutte le migliori proposte per arredare la parete, dalle più classiche alle più moderne e originali.

Un gioco di pannelli, cremagliere e montanti proposti in finiture esclusive e fuori dagli schemi per rendere l'arredo a muro non solo una soluzione espositiva ma un vero decoro.

Pannelli stampati, appenderie colorate, effetti di luce. La parete può diventare il focal point del punto vendita.

L'introduzione dei pannelli magnetici rende tutto ancora più versatile permettendo di sfruttare e arredare anche gli spazi più difficili.

Con la collezione Wall System la bellezza si fonde con la funzionalità, basta solo usare la fantasia e le giuste combinazioni di prodotti e finiture.

*Our Wall System Collection offers the best wall systems, from classic to the modern styles these are out of the box solutions.*

*Wall furniture is not just a simple display solution, it sets the tone of the whole interior with panels and uprights that can set the mood of the whole store.*

*Printed wall panels, coloured display bars, light effects: your walls can become the focal point of the store.*

*Our versatile magnetic panels allow you to decorate every space, even the most crowded areas.*

*In our Wall System Collection, beauty merges with functionality: you only have to use your imagination and the right combination of products and finishings.*

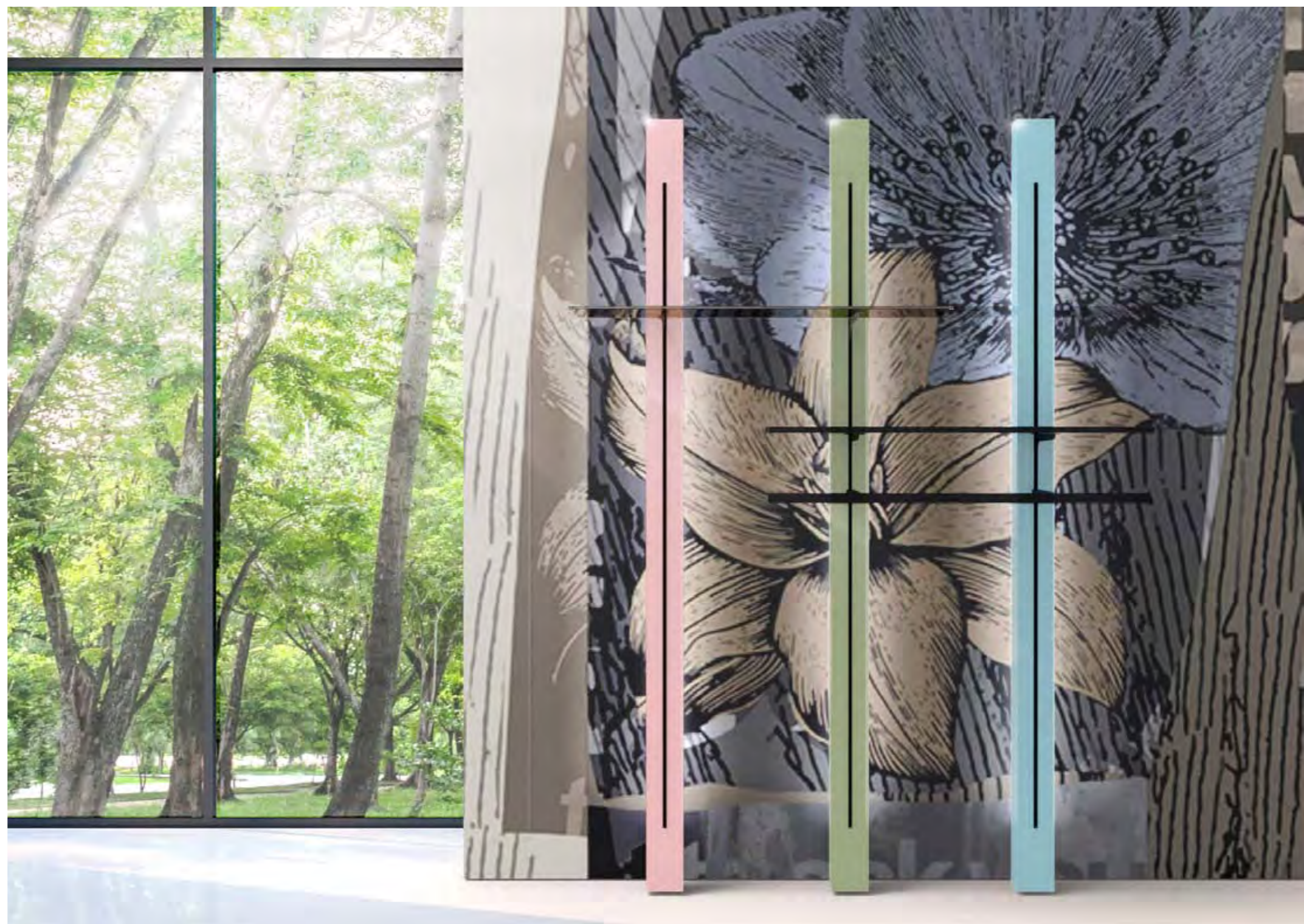

Montanti a parete con sistema a cremagliera retroilluminati / struttura in nobilitato laccato Quartz Pink, Cement Gray, Paradise Azure (da sinistra a destra) / mensole in nobilitato nero opaco e vetro / cremagliera, barra appenderia e reggimensole in metallo finitura nero opaco  
*Backlit wall uprights with racks / structure in Quartz Pink, Cement Gray and Paradise Azure chipboard (from left to right) / shelves in Matt Black chipboard and glass / matt black metal painted racks, hanging bar and brackets*



*Montanti a parete con sistema a cremagliera*  
*Wall uprights with rack system*



Montanti a parete con sistema a cremagliera / struttura in nobilitato Grigio, Vulcano, Noce Bruno (da sinistra a destra) / inserto in nobilitato laccato oro / mensole in nobilitato bianco opaco / cremagliera, barra appenderia e reggimensole in metallo verniciato Oro Anodic  
*Wall uprights with racks / structure in Grigio, Vulcano and Noce Bruno chipboard (from left to right) / front insert in gold chipboard / shelves in Matt White chipboard / Oro Anodic metal painted racks, hanging bar and brackets*



*Elementi a parete con sistema a cremagliera*  
*Wall elements with rack system*



*Elementi a parete con sistema a cremagliera / pannello in nobilitato Calce / cremagliere e barre appenderia in metallo verniciato nero opaco*  
*Wall elements with rack system / panel in Calce chipboard / matt black metal painted racks and hanging bar*



*Wall Gallery*  
*Wall Gallery*



*Elemento a parete Wall Gallery / pannello in metallo verniciato Marsala / boccole finitura bronzo / mensole calamitate verniciate bronzo*  
*Wall Gallery wall elements / Marsala metal painted panel / Bronze painted plugs / Bronze magnetised metal painted shelves*



*Elementi a parete con sistema a boccola*  
*Wall elements with plug-in system*



Elementi a parete con sistema a boccola / pannello in nobilitato bianco opaco / mensole in nobilitato nero opaco / boccole, barre appenderia, reggi mensole in nero opaco

*Wall elements with plug-in system / panel in Matt White chipboard / shelves in Matt Black chipboard / matt black plugs, hanging bars and brackets*



*Elementi a parete con sistema dogato*  
*Wall elements with slat system*



*Elementi a parete con sistema dogato / pannello Bello (sinistra) e Tric & Trac (destra) in nobilitato calce con stampa Flowers / fasce divisorie in nobilitato Rovere Americano / doghe in bianco opaco*

*Wall element with slat system / Bello panel (left) and Tric & Trac panel (right) in Calce chipboard with UV-printed Flower decoration / dividing strips in Rovere Americano chipboard / matt white metal painted slats*



*Elementi a parete con sistema dogato*  
*Wall elements with slat system*









Elementi a parete con sistema dogato / pannelli Zigo Zago in nobilitato Marmo Bianco e Marmo Nero / doghe verniciate Oro Anodic  
*Wall elements with slat system / Zigo Zago panel in Marmo Bianco and Marmo Nero chipboard / Oro Anodic metal painted slats*



# #Legende<sup>DEU</sup>

| PANEELE AUSFÜHRUNGEN |   |
|----------------------|---|
| N                    | Ausführung Mat Neutrales                                |
| S                    | Ausführung Mat Speziell                                 |
| L                    | Ausführung Mat Luxury                                   |
| SONDERAUSFÜHRUNGEN   |   |
| G                    | Gedrucktes Dekor auf Paneele                            |
| F                    | Sonder-Dekor und weitere Bearbeitungen (z.B. Fräsungen) |
| P                    | Sonderlackierungen                                      |
| MASSIVHOLZ           |   |
| R                    | Eiche   |
| W                    | Nussbaum  |
| GLASS                |   |
| V                    | glass hell  |
| VF                   | glass rauchfarbe  |

| ANDERE OPTIONEN   |  |
|---|--|
|  | Kit Rollen eingesteckt   |
|  | Kit sichtbaren Rollen  |
|  | Plexiglas Schutz-Leiste für Metallstange   |
|  | Einzel-Verpackung auf Anfrage  |
|  | Kunstleder-Verkleidung   |
|  | Bearbeitung auf Gehrung 45°, bitte den Code "-45" der Standard Artikel Nummer hinzufügen ([code]-45/...) |
|  | Sonderlackierung auf Anfrage   |







| METALLAUSFÜHRUNGEN                          |                                |
|---|--------------------------------|
| BASIC LACKIERTE, PAINTED BASIC              |                                |
| TO  | Roh-Klarlack pulverbeschichtet |
| NO  | Schwarz pulverbeschichtet      |
| BO  | Weiss pulverbeschichtet        |
| SPECIAL LACKIERTE                           |                                |
| OA  | Oro Anodic (Gold Anodic)       |
| BZ  | Bronzo (Bronze)                |
| CH  | Champagne (Champagne)          |
| MT  | Mattone (Ziegelstein)          |
| RA  | Rame (Kupfer)                  |
| CT  | Corten (Corten)                |
| BR  | Brunito (Bruniert)             |
| Ts  | Tesla (Tesla)                  |
| RAL PULVERBESCHICHTUNG (Preise auf Anfrage) |                                |
| RAL   | RAL Farbe auf Anfrage          |

| GALVANISCHE METALLAUSFÜHRUNGEN |                   |
|--------------------------------|-------------------|
| GLÄNZEND BASIC                 |                   |
| OL                             | Messing glänzend  |
| CL                             | Chrome glänzend   |
| GLÄNZEND SONDERFARBE           |                   |
| RL                             | Kupfer glänzend   |
| GEBÜRSTETE BASIC               |                   |
| OS                             | Messing gebürstet |
| NS                             | Nickel gebürstet  |
| GEBÜRSTETE SONDERFARBE         |                   |
| RS                             | brushed copper    |



# #Legenda<sup>ITA</sup>

| FINITURE PANNELLI             |   |
|-------------------------------|---|
| N                             | nobilitato in finiture Neutral              |
| S                             | nobilitato in finiture Special              |
| L                             | nobilitato in finiture Luxury               |
| STAMPE E LAVORAZIONI SPECIALI |   |
| G                             | stampa decorativa su pannello               |
| F                             | pannello con lavorazioni speciali e laccato |
| P                             | laccatura con colori speciali               |
| LEGNO MASSELLO                |   |
| R                             | rovere                                      |
| W                             | noce  |
| VETRO                         |   |
| V                             | vetro extra chiaro                          |
| VF                            | vetro fumè                                  |

| ALTRE OPZIONI   |  |
|---|--|
|  | kit ruote incassate opzionale  |
|  | kit ruote a vista opzionale  |
|  | protezione plexiglas per barra appenderia  |
|  | possibilità di imballo singolo su richiesta  |
|  | elemento rivestito in ecopelle   |
|  | accoppiamento pannelli a 45°, +15% sul prezzo finale aggiungere dopo il codice "-45" ([code]-45/...) |
|  | possibilità di verniciatura personalizzata, con prezzi a richiesta                                   |

| METALLI VERNICIATI                  |                                |
|-------------------------------------|--------------------------------|
| VERNICIATI BASIC, PAINTED BASIC     |                                |
| TO                                  | trasparente opaco              |
| NO                                  | nero opaco                     |
| BO                                  | bianco opaco                   |
| VERNICIATI SPECIAL                  |                                |
| OA                                  | oro anodico                    |
| BZ                                  | bronzo                         |
| CH                                  | champagne                      |
| MT                                  | mattoni                        |
| RA                                  | rame                           |
| CT                                  | corten                         |
| BR                                  | brunito                        |
| TS                                  | tesla                          |
| VERNICIATI RAL (prezzi a richiesta) |                                |
| RAL                                 | colorazioni ral personalizzate |

| METALLI GALVANICI               |                   |
|---------------------------------|-------------------|
| LUCIDI BASIC, SHINY BASIC       |                   |
| OL                              | ottone lucido     |
| CL                              | cromo lucido      |
| LUCIDI SPECIAL                  |                   |
| RL                              | rame lucido       |
| SPAZZOLATI BASIC, BRUSHED BASIC |                   |
| OS                              | ottone spazzolato |
| NS                              | nikel spazzolato  |
| SPAZZOLATI SPECIAL              |                   |
| RS                              | rame spazzolato   |



# #Key<sup>ENG</sup>

| CHIPBOARD FINISHES             |                                       |
|--------------------------------|---------------------------------------|
| N                              | chipboard Neutral finishes            |
| S                              | chipboard Special finishes            |
| L                              | chipboard Luxury finishes             |
| PRINTS AND SPECIAL DECORATIONS |                                       |
| G                              | panel with decorative print           |
| F                              | panel with special processing/working |
| P                              | panel lacquered with special colours  |
| SOLID WOOD                     |                                       |
| R                              | oak                                   |
| W                              | walnut                                |
| GLASS                          |                                       |
| V                              | extra clear glass                     |
| VF                             | smoked glass                          |

| OTHER OPTIONS   |   |
|---|---|
|  | hidden castors kit upon request   |
|  | visible castors kit upon request  |
|  | plexiglas protection for hanging bar  |
|  | individual packaging upon request   |
|  | eco-leather upholstered element   |
|  | panels with 45° joint, +15% on final price add "-45" after the code ([code]-45/...) |
|  | custom painting is available, price upon request                                    |







| PAINTED METAL                     |                                 |
|-----------------------------------|---------------------------------|
| PAINTED BASIC                     |                                 |
| TO                                | matt transparent powder coating |
| NO                                | matt black powder coating       |
| BO                                | matt white powder coating       |
| PAINTED SPECIAL                   |                                 |
| OA                                | anodic gold powder coating      |
| BZ                                | bronze powder coating           |
| CH                                | champagne powder coating        |
| MT                                | brick powder coating            |
| RA                                | copper powder coating           |
| CT                                | corten powder coating           |
| BR                                | brunished powder coating        |
| TS                                | tesla powder coating            |
| PAINTED RAL (prices upon request) |                                 |
| RAL                               | RAL colours upon request        |

| GALVANIC METAL  |                |
|-----------------|----------------|
| SHINY BASIC     |                |
| OL              | shiny brass    |
| CL              | shiny chrome   |
| SHINY SPECIAL   |                |
| RL              | shiny copper   |
| BRUSHED BASIC   |                |
| OS              | brushed brass  |
| NS              | brushed nikel  |
| BRUSHED SPECIAL |                |
| RS              | brushed copper |



# #Légende<sup>FRA</sup>

| FINITIONS MELAMINE  |                                   |
|---------------------|-----------------------------------|
| N                   | finition mélaminé mat neutre      |
| S                   | finition mélaminé mat spécial     |
| L                   | finition mélaminé mat Luxury      |
| FINITIONS SPECIALES |                                   |
| G                   | décor imprimé sur panneau         |
| F                   | panneau avec opérations spéciales |
| P                   | laque avec couleurs spéciales     |
| BOIS MASSIF         |                                   |
| R                   | chêne                             |
| W                   | noyer                             |
| VERRE               |                                   |
| V                   | verre extra claire                |
| VF                  | verre fumé                        |

| AUTRES OPTION   |  |
|---|--|
|  | Kit roulettes intégré sur la base  |
|  | Kit roulettes visible  |
|  | Protection plexi pour barre penderie   |
|  | Emballage individuel sur demande   |
|  | Revêtement en tissu/similicuir   |
|  | Fabrication à 45°, +15% sur le prix Tarif à ajouter "-45" sur le code standard ([code]-45/...) |
|  | Possibilité de peinture sur demande, prix à convenir   |

| FINITIONS MÉTAL                 |                                    |
|---------------------------------|------------------------------------|
| PEINTURE BASIQUE, PAINTED BASIC |                                    |
| TO                              | peinture epoxy brut transparent    |
| NO                              | peinture epoxy noir                |
| BO                              | peinture epoxy blanc               |
| PEINTURE SPECIALE               |                                    |
| OA                              | Oro Anodic (Or Anodic)             |
| BZ                              | Bronzo (Bronze)                    |
| CH                              | Champagne (Champagne)              |
| MT                              | Mattone (Brique)                   |
| RA                              | Rame (Cuivre)                      |
| CT                              | Corten (Corten)                    |
| BR                              | Brunito (Bruni)                    |
| BR                              | Tesla (Tesla)                      |
| PEINTURE RAL (prix sur demande) |                                    |
| RAL                             | peinture sur demande personnalisée |

| MÉTAL GALVANIQUES                      |                 |
|--|-----------------|
| FINITION BRILLANT BASIQUE, SHINY BASIC |                 |
| OL                                     | Laiton brillant |
| CL                                     | Chrome brillant |
| BRILLANT SPECIALE                      |                 |
| RL                                     | Crivre brillant |
| FINITION BROSSE BASIQUE, BRUSHED BASIC |                 |
| OS                                     | Laiton brossé   |
| NS                                     | nickel brossé   |
| BROSSE SPECIALE                        |                 |
| RS                                     | cuivre brossé   |



# WALL SYSTEM

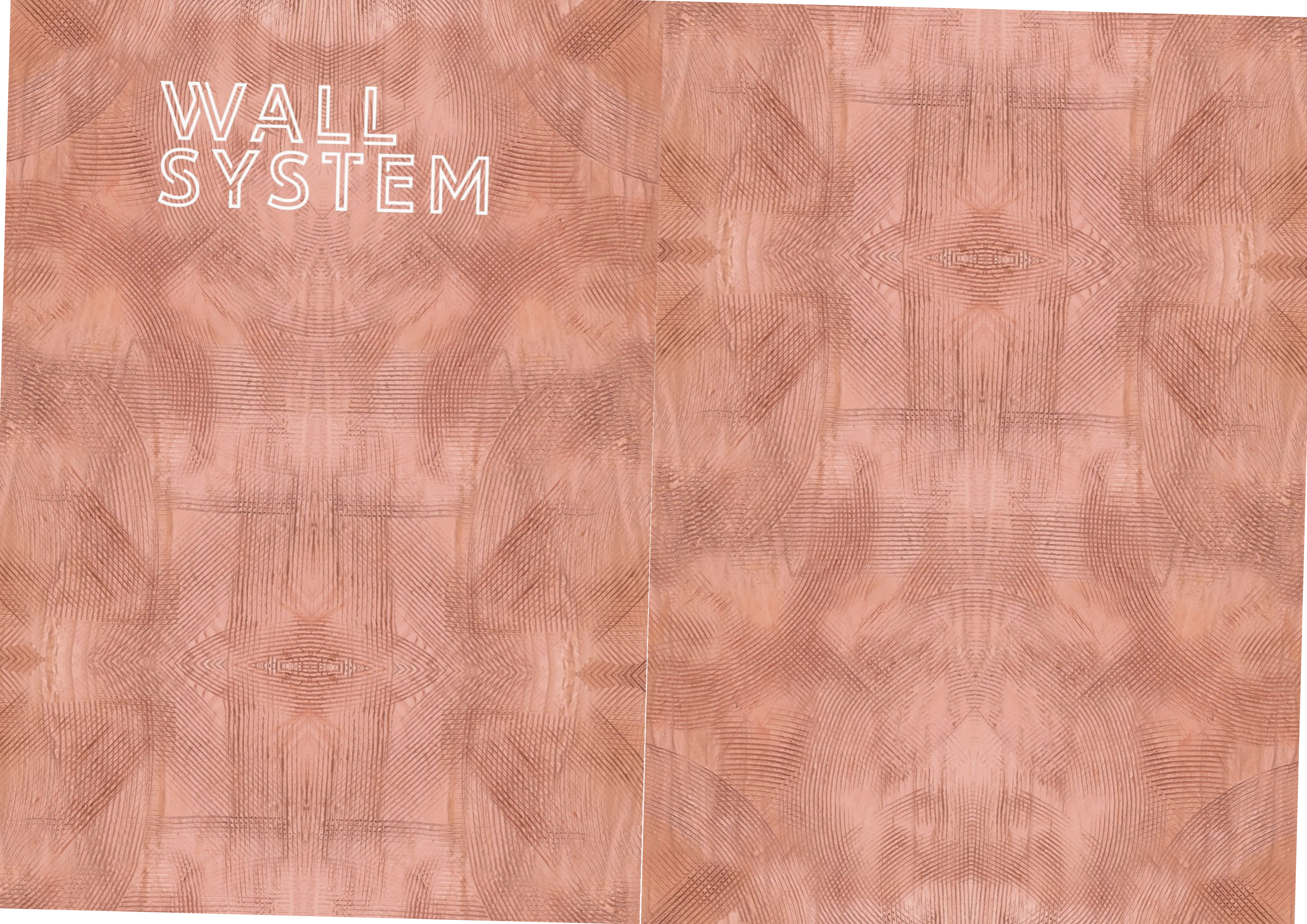



Sistema a cremagliera  
Rack system

Pannelli con cremagliera in alluminio grezzo  
Panels with raw alu rack

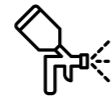

con cremagliere verniciate RAL prezzi a richiesta  
with RAL painted racks prices upon request



cremagliere elettrificate per accessori led su richiesta  
electrified racks for accessories with led lighting upon request

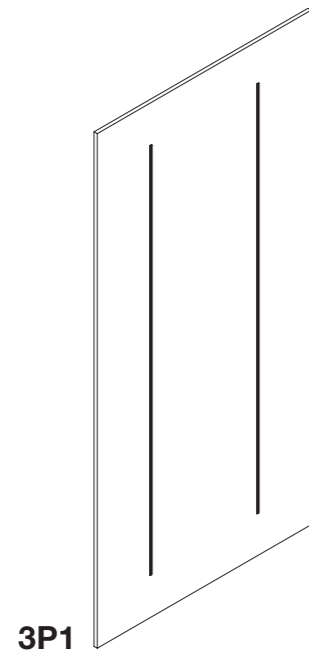

3P1

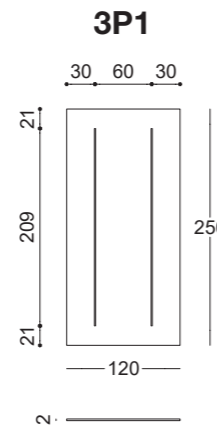

Aggiungere n.3 kit attaccaglie  
(3PFIX1 oppure 3PFIX2)  
Add n.3 fixing kits  
(3PFIX1 or 3PFIX2)

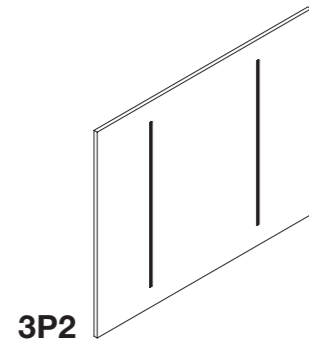

3P2

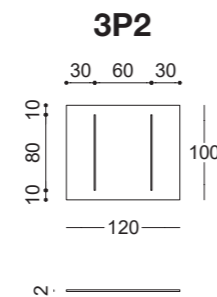

Aggiungere n.2 kit attaccaglie  
(3PFIX1 oppure 3PFIX2)  
Add n.2 fixing kits  
(3PFIX1 or 3PFIX2)

|               |          |          |          |          |          |
|---------------|----------|----------|----------|----------|----------|
| <b>3P1</b>    | <b>N</b> | <b>S</b> | <b>L</b> | <b>P</b> | <b>G</b> |
| ALU           |          |          |          |          |          |
| PAINTED BASIC |          |          |          |          |          |

|               |          |          |          |          |          |
|---------------|----------|----------|----------|----------|----------|
| <b>3P2</b>    | <b>N</b> | <b>S</b> | <b>L</b> | <b>P</b> | <b>G</b> |
| ALU           |          |          |          |          |          |
| PAINTED BASIC |          |          |          |          |          |

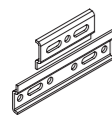

**3PFIX1**

Kit attaccaglie metalliche per pannelli con cremagliera,  
composto da n.1 barra e n.3 attaccaglie  
Metal fixing kit for panels with racks, consisting of n.1  
bar and n.3 hangs

|               |  |
|---------------|--|
| <b>3PFIX1</b> |  |
|               |  |



**3PFIX2**

Kit attaccaglie in MDF per pannelli con  
cremagliera, composto da n.2 profili in mdf  
MDF fixing kit for panels with racks, consisting  
of n.2 mdf bars

|               |  |
|---------------|--|
| <b>3PFIX2</b> |  |
|               |  |

Sistema a cremagliera  
Rack system

Pannelli con cremagliera in alluminio grezzo  
e retroilluminazione opzionale  
Panels with raw alu rack and optional backlight

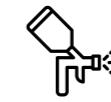

con cremagliere verniciate RAL prezzi a richiesta  
with RAL painted racks prices upon request



cremagliere elettrificate per accessori led su richiesta  
electrified racks for accessories with led lighting upon request

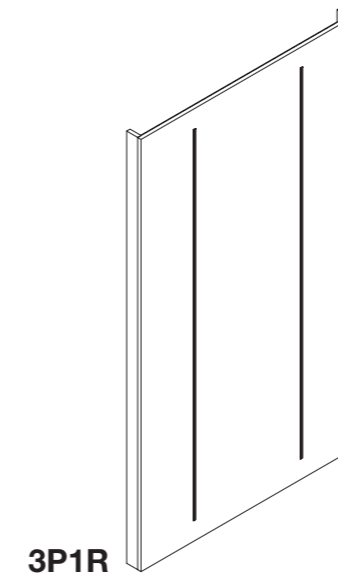

3P1R

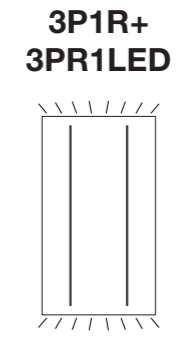
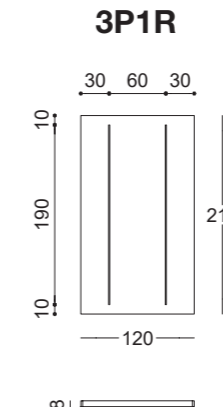

Aggiungere n.2 kit attaccaglie  
(3PFIX1 oppure 3PFIX2)  
Add n.2 fixing kits  
(3PFIX1 or 3PFIX2)

**3PR1LED**  
kit led for 3P1R/3PR2R

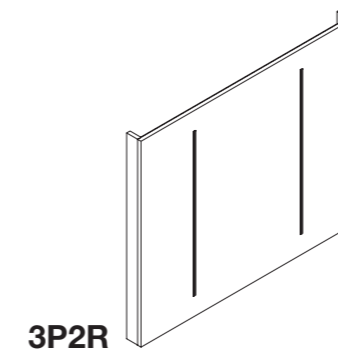
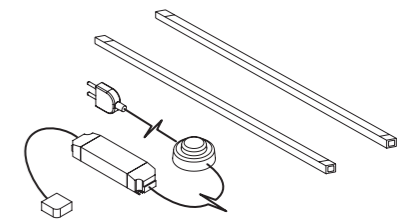

3P2R

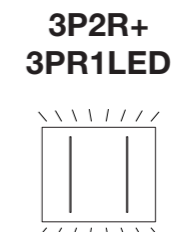
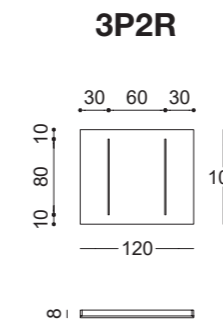

Aggiungere n.2 kit attaccaglie  
(3PFIX1 oppure 3PFIX2)  
Add n.2 fixing kits  
(3PFIX1 or 3PFIX2)

|               |          |          |          |          |          |
|---------------|----------|----------|----------|----------|----------|
| <b>3P1R</b>   | <b>N</b> | <b>S</b> | <b>L</b> | <b>P</b> | <b>G</b> |
| ALU           |          |          |          |          |          |
| PAINTED BASIC |          |          |          |          |          |

|               |          |          |          |          |          |
|---------------|----------|----------|----------|----------|----------|
| <b>3P2R</b>   | <b>N</b> | <b>S</b> | <b>L</b> | <b>P</b> | <b>G</b> |
| ALU           |          |          |          |          |          |
| PAINTED BASIC |          |          |          |          |          |

|                |  |
|----------------|--|
| <b>3PR1LED</b> |  |
|                |  |

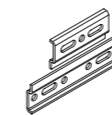

**3PFIX1**

Kit attaccaglie metalliche per pannelli con cremagliera,  
composto da n.1 barra e n.3 attaccaglie  
Metal fixing kit for panels with racks, consisting of n.1  
bar and n.3 hangs

|               |  |
|---------------|--|
| <b>3PFIX1</b> |  |
|               |  |



Sistema a cremagliera  
Rack system

Montanti flat con cremagliera in alluminio grezzo  
Flat uprights with raw alu rack

**LEB** cremagliere elettrificate per accessori led su richiesta  
electrified racks for accessories with led lighting upon request

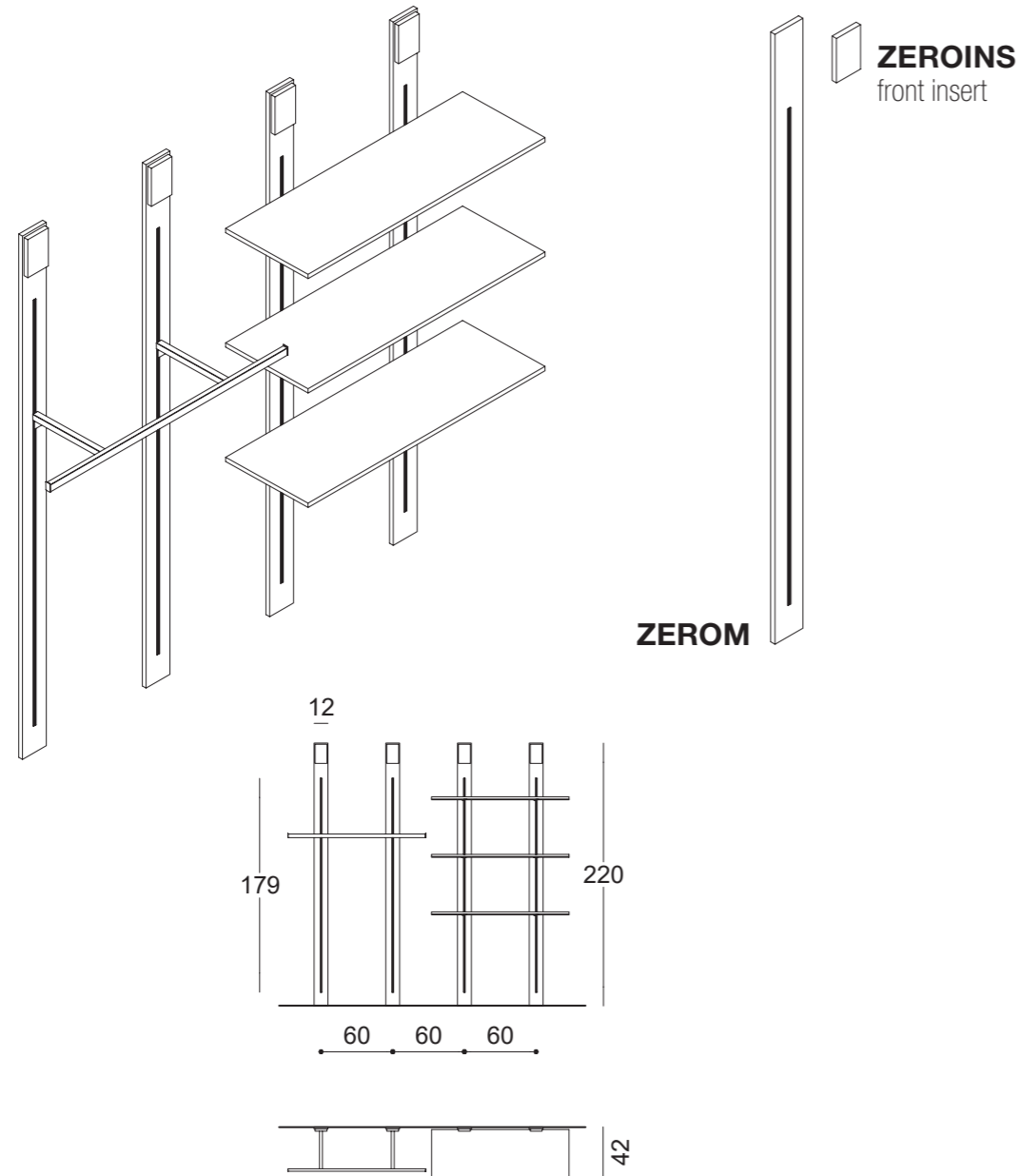

|               |          |          |          |          |          |
|---------------|----------|----------|----------|----------|----------|
| <b>ZEROM</b>  | <b>N</b> | <b>S</b> | <b>L</b> | <b>P</b> | <b>G</b> |
| ALU           |          |          |          |          |          |
| PAINTED BASIC |          |          |          |          |          |

|                |          |          |          |          |          |
|----------------|----------|----------|----------|----------|----------|
| <b>ZEROINS</b> | <b>N</b> | <b>S</b> | <b>L</b> | <b>P</b> | <b>G</b> |
|                |          |          |          |          |          |

 con cremagliere verniciate RAL prezzi a richiesta  
with RAL painted racks prices upon request

per finiture metallo SPECIAL **+10%** rispetto alla finitura metallo BASIC for SPECIAL metal finishes **+10%** on BASIC metal finishes

Sistema a cremagliera  
Rack system

Montanti scatolati con cremagliera in alluminio grezzo  
e retroilluminazione opzionale  
Squared uprights with raw alu rack and optional backlight

**LEB** cremagliere elettrificate per accessori led su richiesta  
electrified racks for accessories with led lighting upon request

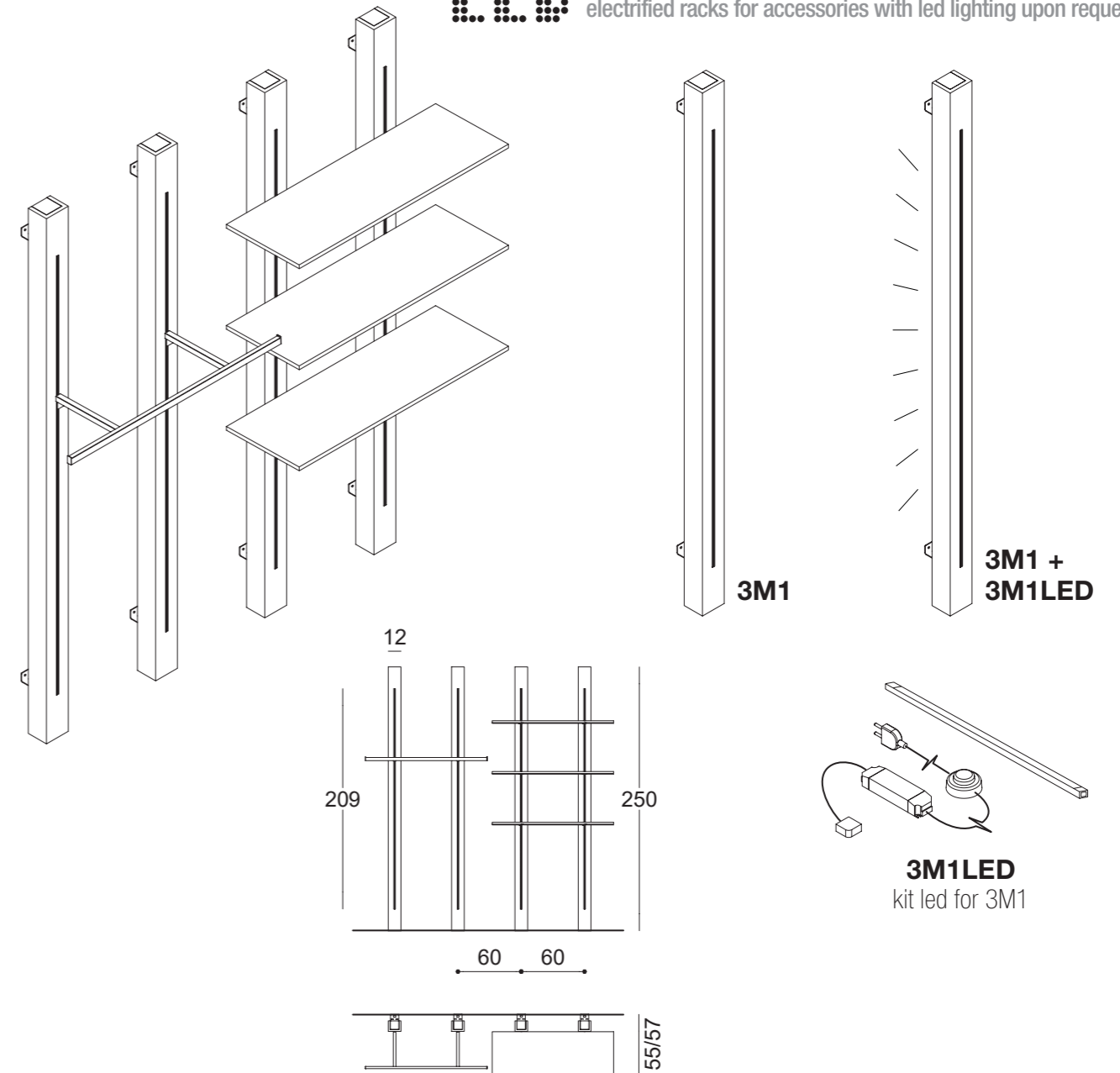

|               |          |          |          |          |
|---------------|----------|----------|----------|----------|
| <b>3M1</b>    | <b>N</b> | <b>S</b> | <b>L</b> | <b>P</b> |
| ALU           |          |          |          |          |
| PAINTED BASIC |          |          |          |          |

|               |  |
|---------------|--|
| <b>3M1LED</b> |  |
|               |  |

 con cremagliere verniciate RAL prezzi a richiesta  
with RAL painted racks prices upon request

per finiture metallo SPECIAL **+10%** rispetto alla finitura metallo BASIC for SPECIAL metal finishes **+10%** on BASIC metal finishes



Accessori per sistema a cremagliera  
Accessories for rack system

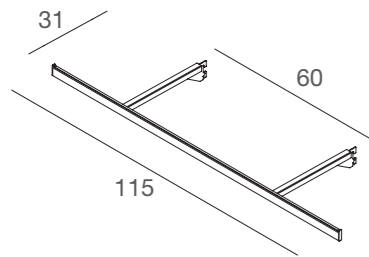

**WSBAP**  
barra appenderia  
in metallo  
metal hanging bar  
L.115 cm x P. 31 cm

|                      |  |
|----------------------|--|
| <b>WSBAP</b>         |  |
| <b>PAINTED BASIC</b> |  |

**WSBAPPLEX**  
protezione plex barra appenderia *plex protection for hanging bar*  
**+12,00 €**

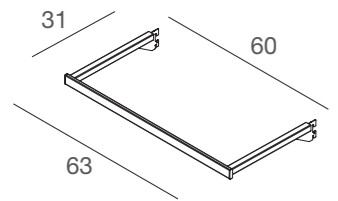

**WSBAP3**  
barra appenderia  
in metallo  
metal hanging bar  
L.63 cm x P. 31 cm

|                      |  |
|----------------------|--|
| <b>WSBAP3</b>        |  |
| <b>PAINTED BASIC</b> |  |

**WSBAP3PLEX**  
protezione plex barra appenderia *plex protection for hanging bar*  
**+9,50 €**

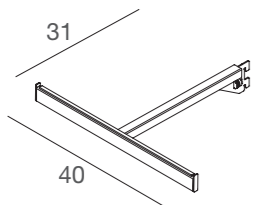

**WSBAP2**  
Barra appenderia piccola in  
metallo con antisbandieramento  
Small metal crossbar with  
anti-swing system  
L.40 x P. 31 cm

|                      |  |
|----------------------|--|
| <b>WSBAP2</b>        |  |
| <b>PAINTED BASIC</b> |  |

**WSBAP2PLEX**  
protezione plex barra appenderia *plex protection for hanging bar*  
**+6,50 €**

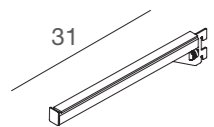

**WSAPF**  
Appenderia frontale dritta in  
metallo con antisbandieramento  
Metal straight front arm with  
anti-swing system  
L.31 cm

|                      |  |
|----------------------|--|
| <b>WSAPF</b>         |  |
| <b>PAINTED BASIC</b> |  |

**WSAPFPLEX**  
protezione plex barra appenderia *plex protection for hanging bar*  
**+6,50 €**

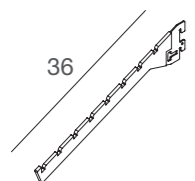

**WSAPFZ**  
Appenderia frontale inclinata  
con antisbandieramento  
Sloping metal front arm  
with anti-swing system  
L.36 cm

|                      |  |
|----------------------|--|
| <b>WSAPFZ</b>        |  |
| <b>PAINTED BASIC</b> |  |

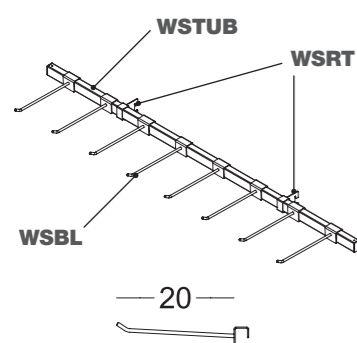

Sistema portablisters  
composto da:  
- WSTUB tubo  
- WSRT coppia reggi-tubo  
- WSBL singolo porta blister  
blister holders system  
- WSTUB tube  
- WSRT pair tube-holder  
- WSBL single blister-holder  
L.115 cm x P. 22 cm

|                      |  |
|----------------------|--|
| <b>WSTUB</b>         |  |
| <b>PAINTED BASIC</b> |  |

|                      |  |
|----------------------|--|
| <b>WSRT</b>          |  |
| <b>PAINTED BASIC</b> |  |

|                      |  |
|----------------------|--|
| <b>WSBLIST</b>       |  |
| <b>PAINTED BASIC</b> |  |

per finiture metallo SPECIAL **+10%** rispetto alla finitura metallo BASIC for SPECIAL metal finishes **+10%** on BASIC metal finishes

Accessori per sistema a cremagliera  
Accessories for rack system

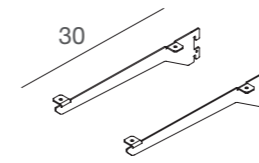

**WSRM**  
Coppia staffe reggimensola  
in metallo per mensola in nobilitato  
Pair of brackets in metal, for chipboard shelf  
L.30 cm

|                      |  |
|----------------------|--|
| <b>WSRM</b>          |  |
| <b>PAINTED BASIC</b> |  |

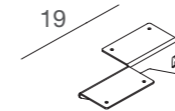

**WSRMM**  
Staffa in metallo, per mensola media e piccola in  
nobilitato, con antisbandieramento  
Single metal bracket for medium and small  
chipboard shelf, with anti-swing system  
L.19 cm

|                      |  |
|----------------------|--|
| <b>WSRMM</b>         |  |
| <b>PAINTED BASIC</b> |  |

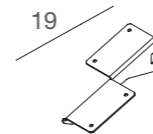

**WSRMMI**  
Staffa in metallo, per mensola media e piccola  
inclinata in nobilitato, con antisbandieramento  
Single metal bracket for sloping medium and  
small chipboard shelf, with anti-swing system  
L.19 cm

|                      |  |
|----------------------|--|
| <b>WSRMMI</b>        |  |
| <b>PAINTED BASIC</b> |  |

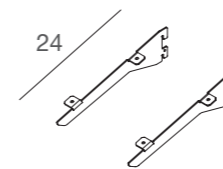

**WSRMI**  
Coppia staffe reggimensola in metallo per  
mensola in nobilitato inclinata  
Pair of metal brackets,  
for sloping chipboard shelf  
L.30 cm

|                      |  |
|----------------------|--|
| <b>WSRMI</b>         |  |
| <b>PAINTED BASIC</b> |  |

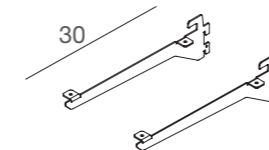

**WSRM/V**  
Coppia staffe reggimensola in metallo, per  
mensola in vetro  
Pair of metal brackets, for glass shelf  
L.30 cm

|                      |  |
|----------------------|--|
| <b>WSRM/V</b>        |  |
| <b>PAINTED BASIC</b> |  |

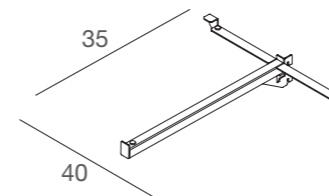

**WSRMM/V**  
Staffa reggimensola in metallo per mensola in  
vetro media, con sistema antisbandieramento  
Metal bracket for medium glass shelf, with anti-  
swing system  
L.40 x P.35 cm

|                      |  |
|----------------------|--|
| <b>WSRMM/V</b>       |  |
| <b>PAINTED BASIC</b> |  |

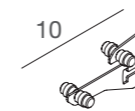

**WSRMS/V**  
Staffa reggimensola in metallo per mensola in  
vetro piccola, con sistema antisbandieramento  
Metal bracket for small glass shelf, with anti-  
swing system  
L.10 cm

|                      |  |
|----------------------|--|
| <b>WSRMS/V</b>       |  |
| <b>PAINTED BASIC</b> |  |



con metallo verniciato RAL prezzi a richiesta  
with RAL painted metal prices upon request

per finiture metallo SPECIAL **+10%** rispetto alla finitura metallo BASIC for SPECIAL metal finishes **+10%** on BASIC metal finishes



Mensole in nobilitato per sistema a cremagliera  
Chipboard shelves for rack system

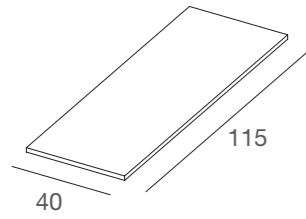

**WSME**  
mensola in nobilitato  
chipboard shelf  
L115 x P40 cm – sp 18 mm

|             |          |          |          |
|-------------|----------|----------|----------|
| <b>WSME</b> | <b>N</b> | <b>S</b> | <b>L</b> |
|             |          |          |          |

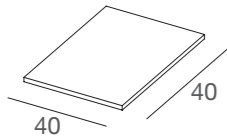

**WSMEM**  
mensola media  
in nobilitato  
chipboard shelf  
L40 x P40 cm – sp 18 mm

|              |          |          |          |
|--------------|----------|----------|----------|
| <b>WSMEM</b> | <b>N</b> | <b>S</b> | <b>L</b> |
|              |          |          |          |

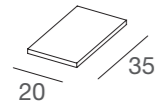

**WSMES**  
mensola piccola  
in nobilitato  
glossy chipboard shelf  
L35 x P20 cm – sp 18 mm

|              |          |          |          |
|--------------|----------|----------|----------|
| <b>WSMES</b> | <b>N</b> | <b>S</b> | <b>L</b> |
|              |          |          |          |

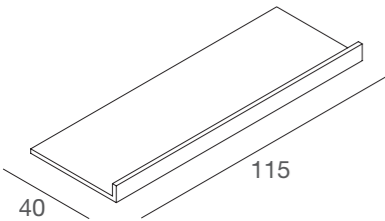

**WSMEI**  
mensola inclinata in nobilitato  
sloping chipboard shelf  
L115 x P40 cm – sp 18 mm

|              |          |          |          |
|--------------|----------|----------|----------|
| <b>WSMEI</b> | <b>N</b> | <b>S</b> | <b>L</b> |
|              |          |          |          |

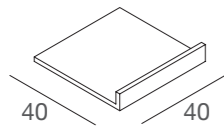

**WSMEIM**  
mensola inclinata in nobilitato  
sloping chipboard shelf  
L40 x P40 cm – sp 18 mm

|               |          |          |          |
|---------------|----------|----------|----------|
| <b>WSMEIM</b> | <b>N</b> | <b>S</b> | <b>L</b> |
|               |          |          |          |

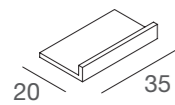

**WSMEIS**  
mensola inclinata in nobilitato  
sloping chipboard shelf  
L35 x P20 cm – sp 18 mm

|               |          |          |          |
|---------------|----------|----------|----------|
| <b>WSMEIS</b> | <b>N</b> | <b>S</b> | <b>L</b> |
|               |          |          |          |

Mensole in vetro per sistema a cremagliera  
Glass shelves for rack system

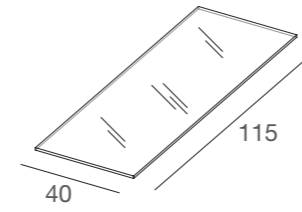

**WSME/V**  
mensola in vetro temperato  
tempered glass shelf  
L115 x P40 cm – sp 8 mm

|                |  |
|----------------|--|
| <b>WSME/V</b>  |  |
| <b>WSME/VF</b> |  |

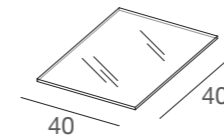

**WSMEM/V**  
mensola media  
in vetro temperato  
medium tempered glass shelf  
L40 x P40 cm – sp 8 mm

|                 |  |
|-----------------|--|
| <b>WSMEM/V</b>  |  |
| <b>WSMEM/VF</b> |  |

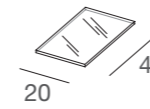

**WSMES/V**  
mensola piccola  
in vetro temperato  
small tempered glass shelf  
L40 x P20 cm – sp 8 mm

|                 |  |
|-----------------|--|
| <b>WSMES/V</b>  |  |
| <b>WSMES/VF</b> |  |

**22mm** disponibilità spessore 22 mm a richiesta, su alcune finiture (vedi file finiture pdf)  
thickness 22 mm available upon request, for some finishes (ref. to pdf finishes file)



Riepilogo accessori per sistema a cremagliera  
Accessories for rack system

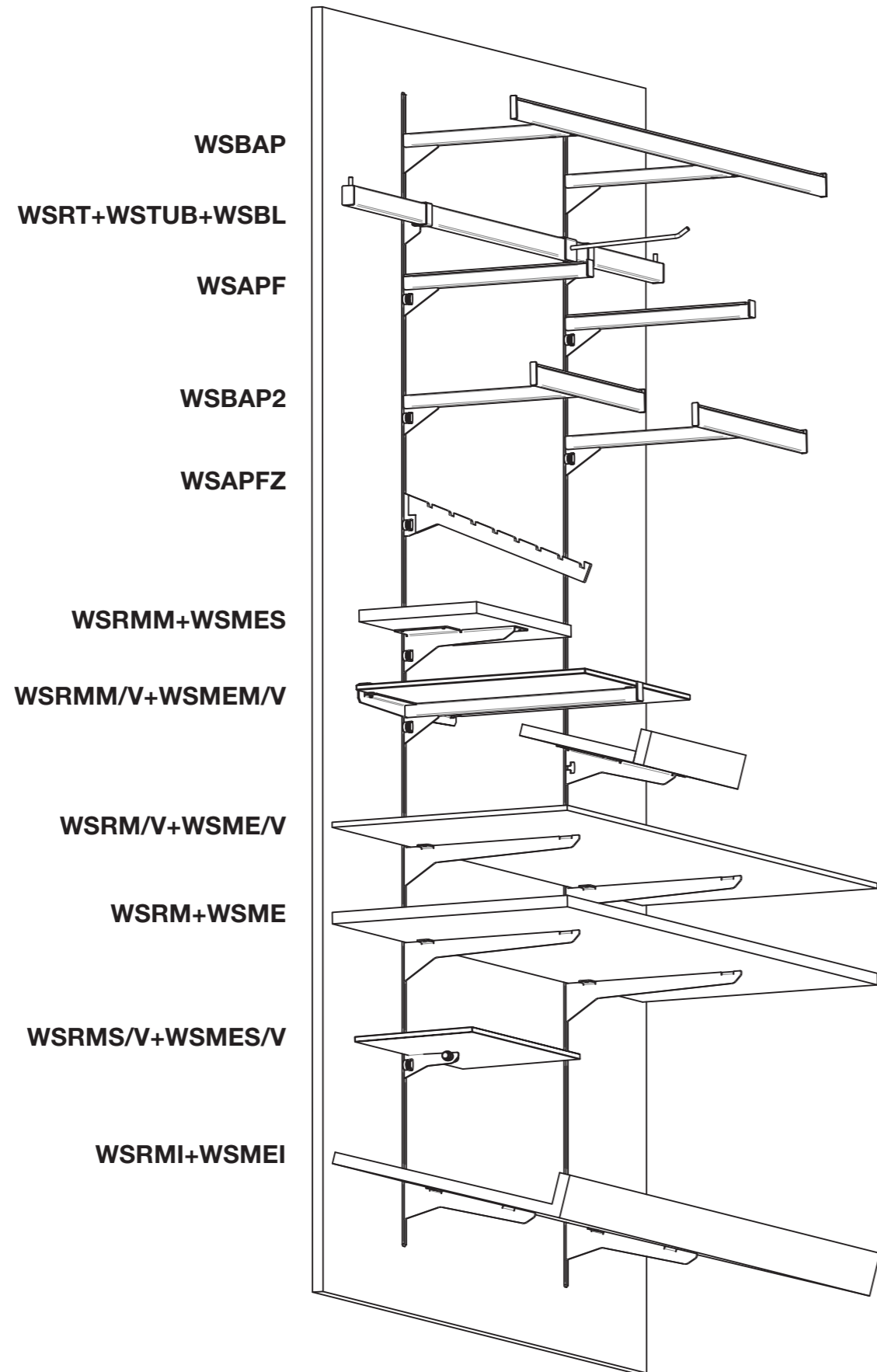

Riepilogo accessori per sistema a cremagliera  
Accessories for rack system

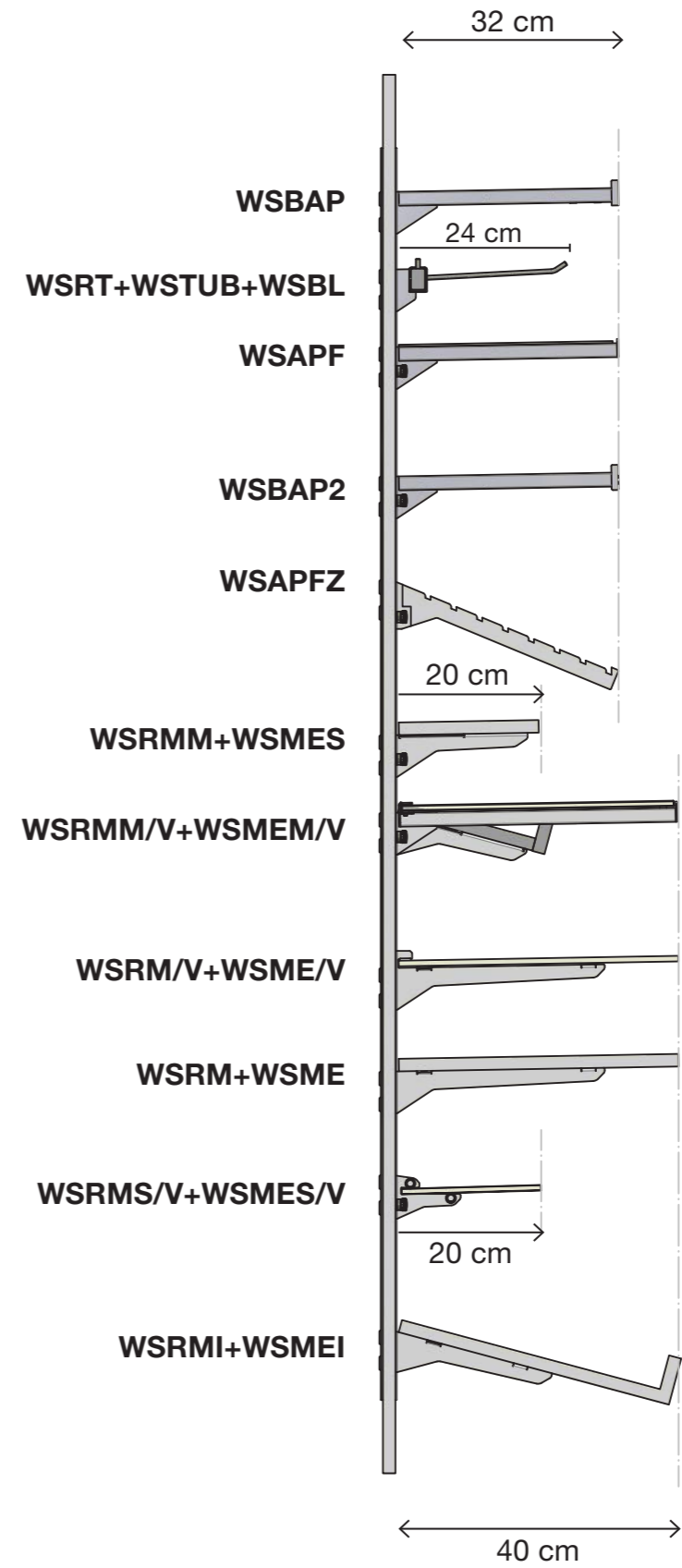



Sistema a boccole  
Plug-in system

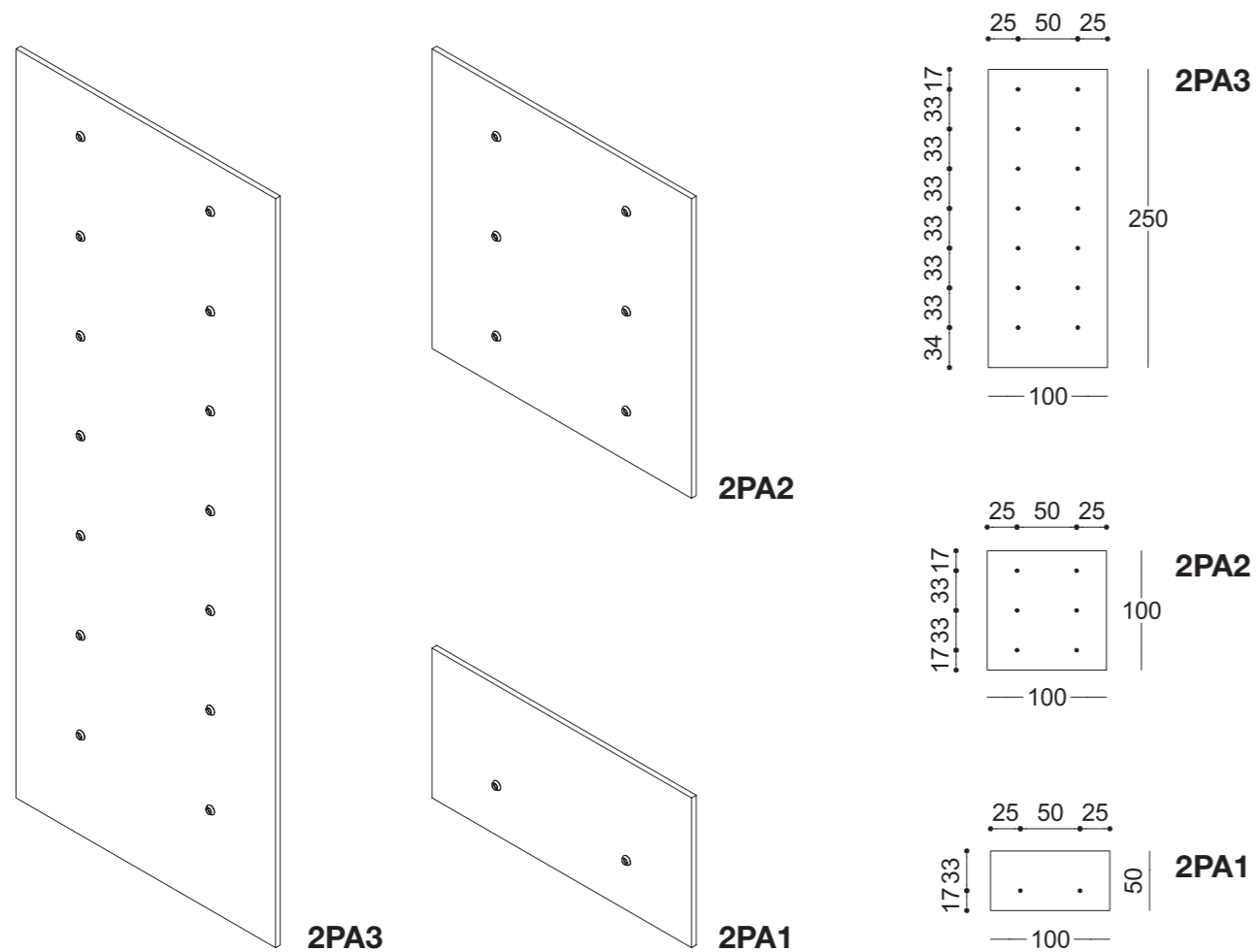

|               |          |          |          |          |          |
|---------------|----------|----------|----------|----------|----------|
| <b>2PA3</b>   | <b>N</b> | <b>S</b> | <b>L</b> | <b>P</b> | <b>G</b> |
| ALU           |          |          |          |          |          |
| PAINTED BASIC |          |          |          |          |          |

|               |          |          |          |          |          |
|---------------|----------|----------|----------|----------|----------|
| <b>2PA2</b>   | <b>N</b> | <b>S</b> | <b>L</b> | <b>P</b> | <b>G</b> |
| ALU           |          |          |          |          |          |
| PAINTED BASIC |          |          |          |          |          |

|               |          |          |          |          |          |
|---------------|----------|----------|----------|----------|----------|
| <b>2PA1</b>   | <b>N</b> | <b>S</b> | <b>L</b> | <b>P</b> | <b>G</b> |
| ALU           |          |          |          |          |          |
| PAINTED BASIC |          |          |          |          |          |

per finiture metallo SPECIAL +10% rispetto alla finitura metallo BASIC for SPECIAL metal finishes +10% on BASIC metal finishes



con cremagliera verniciata RAL prezzi a richiesta  
with RAL painted rack prices upon request

Accessori per sistema a boccole  
Accessories for plug-in system

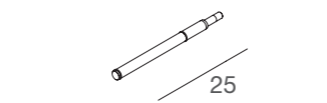

**2PP**  
appendiera frontale in alluminio  
front hanging bar in alu

|               |  |
|---------------|--|
| <b>2PP</b>    |  |
| ALU           |  |
| PAINTED BASIC |  |

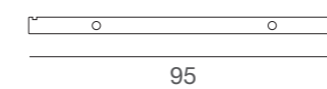

**2BAP**  
barra appendiera in metallo  
straight hanging bar in metal

|               |  |
|---------------|--|
| <b>2BAP</b>   |  |
| ALU           |  |
| PAINTED BASIC |  |

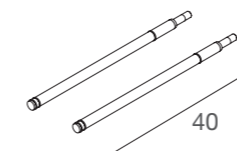
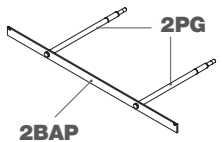

**2PG**  
coppia perni per mensola o barra  
appendiera in alluminio  
pair of supporting pins for shelf  
or hanging bar in alu

|               |  |
|---------------|--|
| <b>2PG</b>    |  |
| ALU           |  |
| PAINTED BASIC |  |

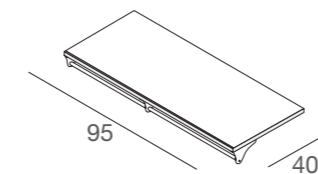

**2MEA**  
mensola in nobilitato  
con appendiera in metallo  
chipboard shelf  
with metal crossbar

|               |          |          |          |
|---------------|----------|----------|----------|
| <b>2MEA</b>   | <b>N</b> | <b>S</b> | <b>L</b> |
| ALU           |          |          |          |
| PAINTED BASIC |          |          |          |

aggiungere sempre articolo **2ARL**  
always add art. **2ARL**

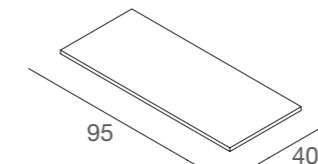

**2ME**  
mensola in nobilitato  
chipboard shelf

|            |          |          |          |
|------------|----------|----------|----------|
| <b>2ME</b> | <b>N</b> | <b>S</b> | <b>L</b> |
|            |          |          |          |

aggiungere sempre articolo **2ARL**  
always add art. **2ARL**

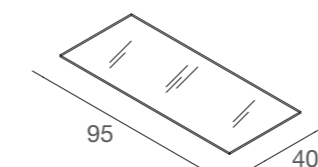

**2ME/V**  
mensola in vetro  
glass shelf

|               |  |
|---------------|--|
| <b>2ME/V</b>  |  |
| <b>2ME/VF</b> |  |

aggiungere sempre articolo **2ARV**  
always add art. **2ARV**

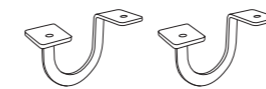

**2ARL**  
coppia ganci antiribaltamento in  
alluminio, per mensole in nobilitato  
pair of alu locking hooks, for  
chipboard shelves

|               |  |
|---------------|--|
| <b>2ARL</b>   |  |
| ALU           |  |
| PAINTED BASIC |  |

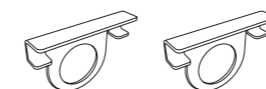

**2ARV**  
coppia ganci antiribaltamento in  
alluminio, per mensole in vetro  
pair of alu locking hooks, for  
glass shelves

|               |  |
|---------------|--|
| <b>2ARV</b>   |  |
| ALU           |  |
| PAINTED BASIC |  |

per finiture metallo SPECIAL +10% rispetto alla finitura metallo BASIC for SPECIAL metal finishes +10% on BASIC metal finishes

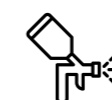

con metallo verniciato RAL prezzi a richiesta  
with RAL painted metal prices upon request



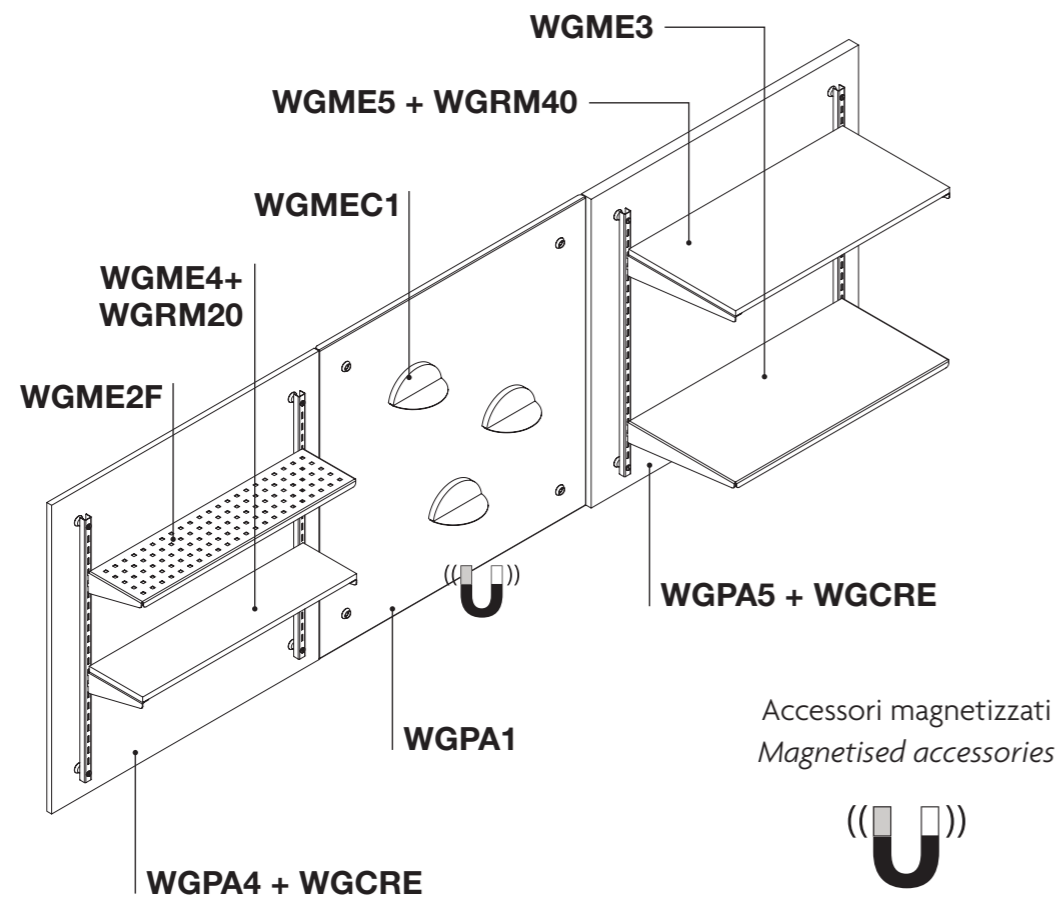

Accessori magnetizzati  
Magnetised accessories

DETTAGLI VISTA FRONTALE (identica per tutti i pannelli)  
DETAILED FRONT VIEW (same for all panels)

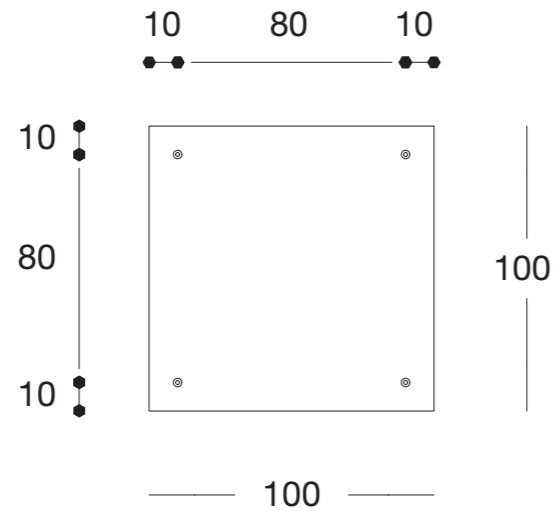

PANNELLO IN FERRO CON 4 BOCCOLE  
IRON PANEL WITH 4 PLUGS

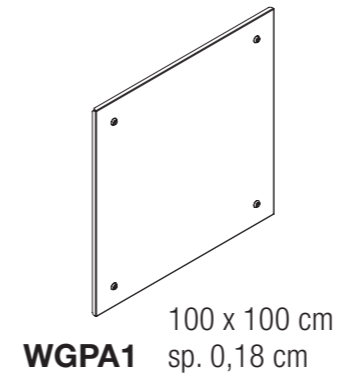

PANNELLO IN NOBILITATO  
SP.18 mm CON 4 BOCCOLE  
CHIPBOARD PANEL  
TH.18 mm WITH 4 PLUGS

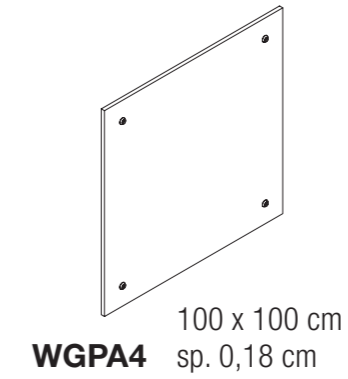

PANNELLO IN NOBILITATO  
SP.36 mm CON 4 BOCCOLE  
CHIPBOARD PANEL  
TH.36 mm WITH 4 PLUGS

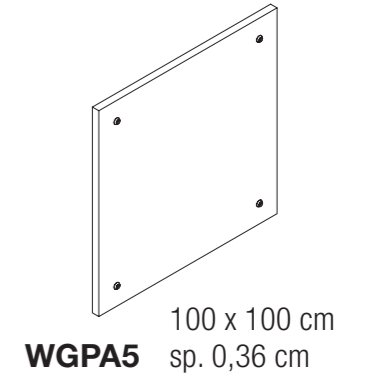

pannello in ferro *iron panel*

|                      |  |
|----------------------|--|
| <b>WGPA1</b>         |  |
| <b>PAINTED BASIC</b> |  |

altre finiture a richiesta  
*other finishes upon request*

pannello nobilitato spessore 18mm *chipboard panel tickness 18mm*

|                      |          |          |          |          |          |          |
|----------------------|----------|----------|----------|----------|----------|----------|
| <b>WGPA4</b>         | <b>N</b> | <b>S</b> | <b>L</b> | <b>P</b> | <b>G</b> | <b>F</b> |
| <b>PAINTED BASIC</b> |          |          |          |          |          |          |

pannello nobilitato spessore 36mm *chipboard panel tickness 36mm*

|                      |          |          |          |          |          |          |
|----------------------|----------|----------|----------|----------|----------|----------|
| <b>WGPA5</b>         | <b>N</b> | <b>S</b> | <b>L</b> | <b>P</b> | <b>G</b> | <b>F</b> |
| <b>PAINTED BASIC</b> |          |          |          |          |          |          |

per finiture metallo SPECIAL **+10%** rispetto alla finitura metallo BASIC for SPECIAL metal finishes **+10%** on BASIC metal finishes

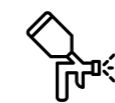

con metallo verniciato RAL prezzi a richiesta  
*with RAL painted metal prices upon request*



**Accessori Wall Gallery**  
*Wall Gallery accessories*

per finiture metallo SPECIAL **+10%** rispetto alla finitura metallo BASIC  
 for SPECIAL metal finishes **+10%** on BASIC metal finishes

per finiture metallo SPECIAL **+10%** rispetto alla finitura metallo BASIC  
 for SPECIAL metal finishes **+10%** on BASIC metal finishes

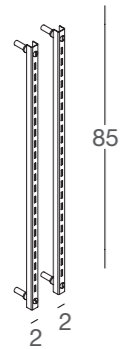

**WGCRE**  
 coppia cremagliere per pannello  
 Wall Gallery  
*pair of racks for Wall Gallery*

|                      |  |
|----------------------|--|
| <b>WGCRE</b>         |  |
| <b>PAINTED BASIC</b> |  |

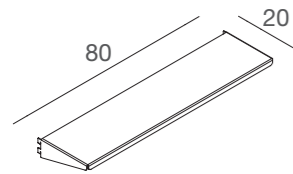

**WGME2**  
 mensola in ferro  
*iron shelf*

|                      |  |
|----------------------|--|
| <b>WGME2</b>         |  |
| <b>PAINTED BASIC</b> |  |

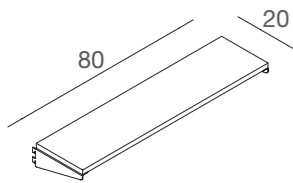

**WGME4 + WGRM20**  
 mensola in nobilitato + coppia  
 staffe reggimensola  
*chipboard shelf with shelf holders*

|                      |          |          |          |
|----------------------|----------|----------|----------|
| <b>WGRM20</b>        |          |          |          |
| <b>PAINTED BASIC</b> |          |          |          |
|                      | <b>N</b> | <b>S</b> | <b>L</b> |
| <b>WGME4</b>         |          |          |          |

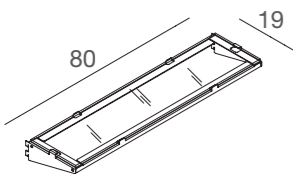

**WGME6**  
 mensola in vetro compresa di  
 reggimensola in ferro  
*glass shelf with iron shelf holders*

|                      |  |
|----------------------|--|
| <b>WGME6</b>         |  |
| <b>PAINTED BASIC</b> |  |

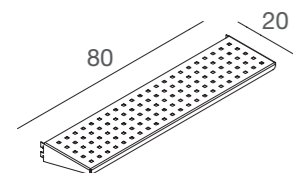

**WGME2F**  
 mensola forata in ferro  
*perforated iron shelf*

|                      |  |
|----------------------|--|
| <b>WGME2F</b>        |  |
| <b>PAINTED BASIC</b> |  |

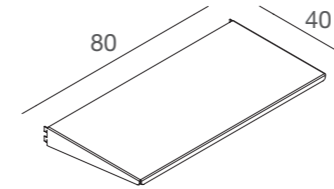

**WGME3**  
 mensola in ferro  
*iron shelf*

|                      |  |
|----------------------|--|
| <b>WGME3</b>         |  |
| <b>PAINTED BASIC</b> |  |

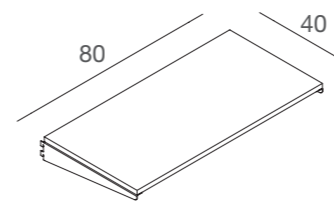

**WGME5 + WGRM40**  
 mensola in nobilitato + coppia  
 staffe reggimensola  
*chipboard shelf with shelf holders*

|                      |          |          |          |
|----------------------|----------|----------|----------|
| <b>WGRM40</b>        |          |          |          |
| <b>PAINTED BASIC</b> |          |          |          |
|                      | <b>N</b> | <b>S</b> | <b>L</b> |
| <b>WGME5</b>         |          |          |          |

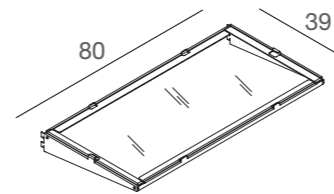

**WGME7**  
 mensola in vetro compresa di  
 reggimensola in ferro  
*glass shelf with iron shelf holders*

|                      |  |
|----------------------|--|
| <b>WGME7</b>         |  |
| <b>PAINTED BASIC</b> |  |

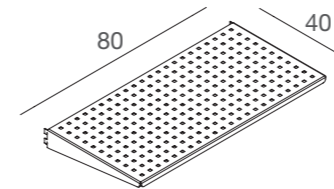

**WGME3F**  
 mensola forata in ferro  
*perforated iron shelf*

|                      |  |
|----------------------|--|
| <b>WGME3F</b>        |  |
| <b>PAINTED BASIC</b> |  |



**WGMEC1**  
 mensola calamitata semicircolare, piano d'appoggio in metallo ed elemento verticale in mdf laccato  
*semicircular magnetised shelf, metal shelf and vertical element in painted mdf*

|                      |          |          |          |          |
|----------------------|----------|----------|----------|----------|
| <b>WGMEC1</b>        | <b>N</b> | <b>S</b> | <b>L</b> | <b>P</b> |
| <b>PAINTED BASIC</b> |          |          |          |          |



## NEUTRAL [N]

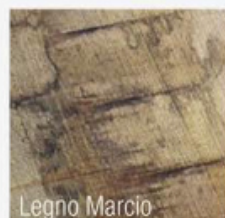
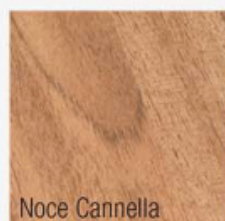

## SPECIAL [S]

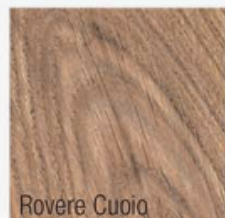
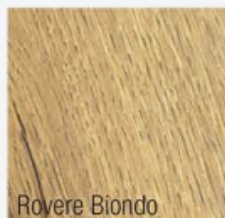



## LUXURY [L]



Possibilità di richiedere vernice RAL / Pantone® / NCS® o stampa personalizzata tramite file vettoriale.  
Alcuni esempi di pannelli laccati e stampati:

*You can request RAL / Pantone® / NCS® paint or a custom print via vector file.  
Some examples of painted and printed panels:*

### LACCATI E STAMPATI SU PANNELLO - CHIPBOARD PAINTED & PRINTED



**METALLI VERNICIATI - PAINTED METALS**

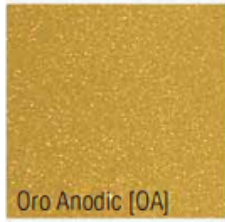

**GALVANICI - GALVANIC**

