



GONDOLE

EASY GAP  
SMART

DANIGHI EASY 2-3-4

UNDER SMILE

Das EASY System ist einfach und schnell montiert. Mit seiner grossen Farbauswahl für die Metallstrukturen und Holzabdeckungen bietet es zahlreiche Möglichkeiten, die Einrichtung individuell zu gestalten. Ideal für die Einrichtung von mittel- und grossflächigen Läden.

*Simple and fast, the EASY system, offers with its wide range of colours for iron structures and wooden coverings, several possibilities to personalize the shop-fitting. It is perfect for shop-fittings of medium and large surfaces.*



Verkaufsgondel mit Frontpräsentation  
*Structure for set of shelves with lateral frame*



U-Schienen mit Glastablar  
*Uprights with glass shelves*

Farben der U-Schienen - *Upright colours*



Verchromt - Alu einbrennlackiert - Weiss - Schwarz einbrennlackiert  
*Chromium-plated - Embossed alu - White - Embossed black*

Farben der Holzverkleidungen - *Covering colours*



Alu-Grau - Wengé - Nuss - Buche - Ahorn  
*Grey Alu - Wengé - Walnut - Beech - Maple*



U-Schiene mit Holzverkleidung  
und verschiedenen Zubehörteilen  
*Upright with wood covering and various accessories*

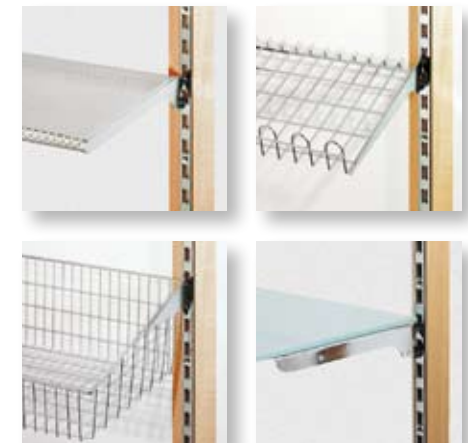



# EASY 2-3-4

Serie

Um den Bedürfnissen der Kunden so gut wie möglich gerecht zu werden, wurden Trägerelemente und Gestelle geschaffen, die so vielseitig und elegant sind, dass sie in den verschiedensten Geschäften verwendet werden können. Zu diesen Strukturen passen alle Easy Zubehörteile. Besondere Zubehörteile wurden entwickelt, die auf der Rückseite der Easy 3 Vertikalstange fixiert werden können.

*To meet at best the requests of customers uprights and pedestals have been created, they are so elegant and versatile that can be used in various kinds of shops. Easy accessories can be used on these structures. Particular elements have been developed to be fixed on the back side of Easy 3 pedestal.*



Easy 2 Einrichtung  
Easy 2 shopfitting



Easy 4 Einrichtung  
Easy 4 shopfitting



Easy 2 U-Schiene und Zubehörteile  
Easy 2 upright and accessories



Easy 3 Einrichtung  
Easy 3 shopfitting



# SMART

## Serie

Die Serie Smart zeichnet sich durch klare Linien aus und ist in 2 Varianten erhältlich, um die Anforderungen der Kunden möglichst gut zu erfüllen. Das System Smart bietet eine modulare Struktur, die einfach zu montieren und einzusetzen ist. Das System Smart 2 verfügt über Zubehörteile, die auf der Rückseite der Vertikalstange montiert werden, sodass die Fixierung nicht zu sehen ist.

*Characterized by an essential line it is available in 2 versions to meet at best the requests of customers.*

*Smart system offers a modular structure easy to assemble and use.*

*Smart 2 system has accessories fixed on the back side of the pedestal making invisible any kind of fixing.*



Smart 2 Wandgestell  
Smart 2 pedestals



Schaufensterpräsentation  
Window dressing

Farbe der Vertikalstange  
Upright colour



Alu einbrennlackiert  
Embossed alu



Zubehörteile Smart und Smart 2  
Smart and Smart 2 accessories





Die Serie Capri mit ihrer breiten Palette von Holzpaneelen und Zubehörteilen kann für die verschiedensten Arten von Läden verwendet werden, vom Sport- bis zum Kleidergeschäft. Zu den erwähnten Komponenten gibt es zusätzlich auch fahrbare Mittelraumwände, die mit den Capri Zubehörteilen verwendet werden können.

*Capri system with its wide range of panels and accessories can be used for various types of shops, from the sport one to the clothes one. With the available components you can also find an upright where the Capri accessories can be used.*



Einrichtung mit Holzpaneelen ahorn  
*Shopfitting with maple panels*



Tragstangen und Abhänger verchromt  
*Chromium-plated racks and linear supports*

Farben der PVC-Schienen - *Insert colours*

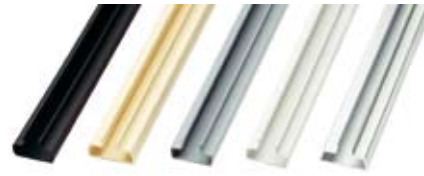

Schwarz Black  
Crème Cream  
Grau Grey  
Weiss White  
Alu Aluminium

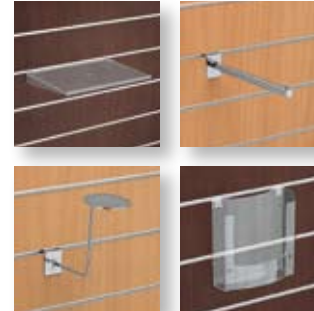
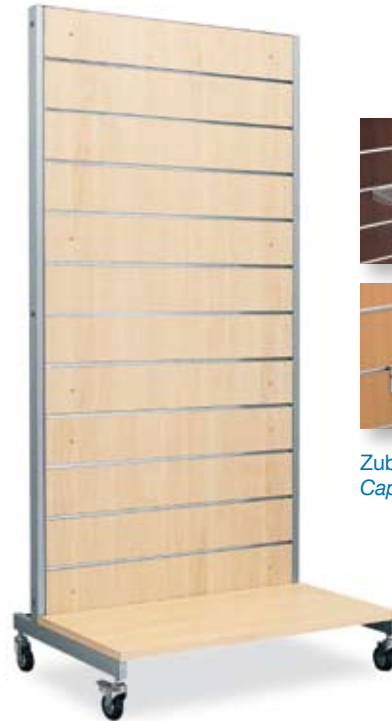

Zubehör für die Capri Serie  
*Capri series accessories*



Zubehör für Capri-Vertikalstange  
*Capri upright accessories*

Farben der Holzpaneelen - *Panel colours*



Weiss White  
Grau Grey  
Crème Cream  
Alu-grau Alu effect



Ahorn Maple  
Buche Beech  
Nuss Walnut  
Wengé Wengé



Capri-Vertikalstange  
*Capri upright*



Holzelemente in den Farben weiss glänzend und schwarz glänzend sowie verchromte Zubehörteile mit innovativen und klaren Formen bilden eine Serie, die besonders für die Einrichtung von edlen und eleganten Geschäften geeignet ist.

*Bright white and bright black panels together with chromium plated accessories with innovative and essential shapes constitute a system particularly suitable to realize fine and elegant shops.*



Smile-Holzelemente mit Glastablar  
*Smile wall with glass shelves*



Glastablar mit Tragstange  
*Glass shelf with hanging bar*



Holzelemente weiss glänzend mit Glastablar und Tragstange  
*Bright white panels with white glass shelves and hanging bars*



Holzelemente weiss glänzend mit Holztablar und Tragstange  
*Bright white panels with wood shelves and hanging bars*

### Farben der Holzelemente - Panel colours



Weiss glänzend  
*Bright white*



Schwarz glänzend  
*Bright black*



Zubehörteile Metall verchromt  
*Iron chromium-plated accessories*



Zur Ergänzung unserer verschiedenen Serien und um den Verkaufsraum möglichst gut zu nutzen, haben Sie die Möglichkeit, Ladentische und verschiedene Zubehöre zu verwenden. Durch die verchromte, alu einbrennlackierte Oberfläche und die klaren Linien lassen sich diese Elemente perfekt in jedes Geschäft integrieren.

*To complete our series and to make maximum use of display spaces you can use Counters and Accessories. Chromium-plated or embossed aluminium finishes and a simple line make these elements perfectly integrated in every shop.*



Beispiel Produkte-Präsentation  
Display example



Verkaufstisch Art. 08102C  
Chromium-plated counter Art. 08102C

### Metallfarben - Metal colours



Verchromt  
Chromium-plated    Alu einbrennlackiert  
Embossed alu

### Holzfarben - Wood colours



Ahorn  
Maple    Buche  
Beech    Nuss  
Walnut    Wengé  
Wengé    Alu-Grau  
Alu Grey

### Farben der Bezüge - Cushion colours



Schwarz  
Black    Reinweiss  
Cream



Art. 08142X



Art. 08002C



Art. 08200X



Art. 08250X



Art. 08220X



# GONDELN

## Serie

Vierkantrohr, verchromte Struktur und Glastablare sind die Hauptmerkmale dieser Elemente. Sie sind vielseitig, einfach zu montieren und bilden eine ideale Ergänzung für die Ladenmitte.

*Square tube, chromium plated structure and white glass shelves are the main characteristics of these elements. Versatile and easy to assemble they complete the central spaces of the shops.*



Verkaufsgondel mit Glastablaren  
*Set of shelf with glass-shelf*



Verkaufsständer verchromt  
*Chromium-plated stand*



Art. 08730C



Zubehörteile für Verkaufsgondeln  
*Accessories for sets of shelves*



Art. 08702C



Art. 08624C

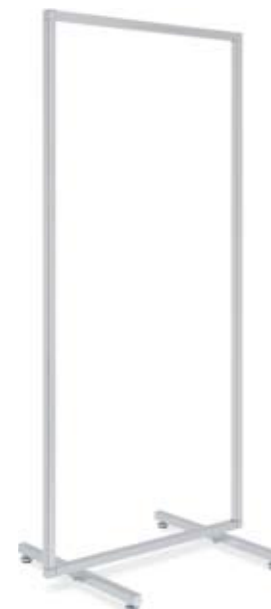

Art. 08601C



Art. 08660C



# STÄNDER

## Serie

Diese Ständer sind unentbehrlich für das Ausstellen und Lagern der verschiedensten Produkten. Dank ihrer Funktionalität und Vielseitigkeit sind sie für die Einrichtung von sowohl kleinen als auch grossen Laden- und Lagerflächen geeignet.

*Stands are all the time essential for display of various products and thanks to their functionality and versatility they can find a large use for shop-fittings of small and large surfaces.*



Kleiderständer mit Auszugarmen  
*Chromium-plated stand*



Gitterkorb verchromt  
*Basket*

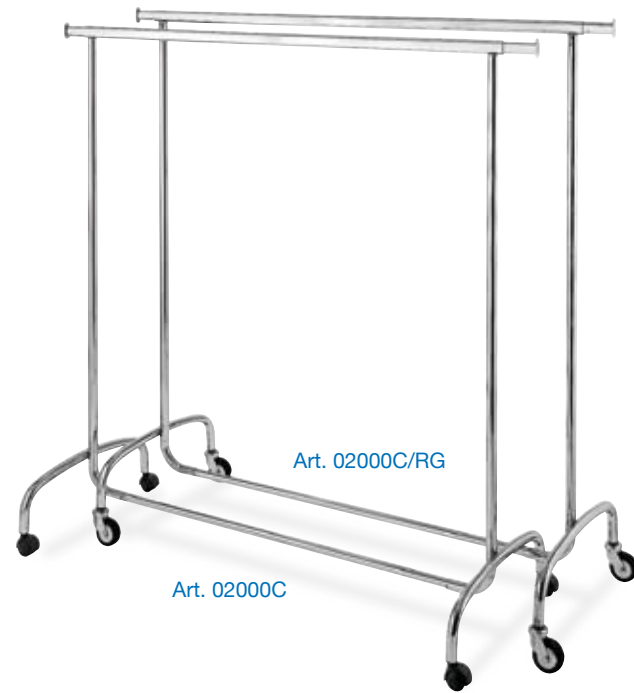

Art. 02000C/RG

Art. 02000C



Art. 02022C

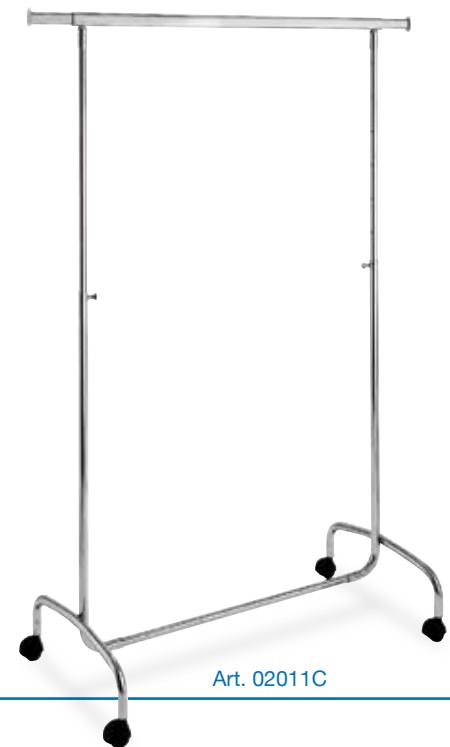

Art. 02011C

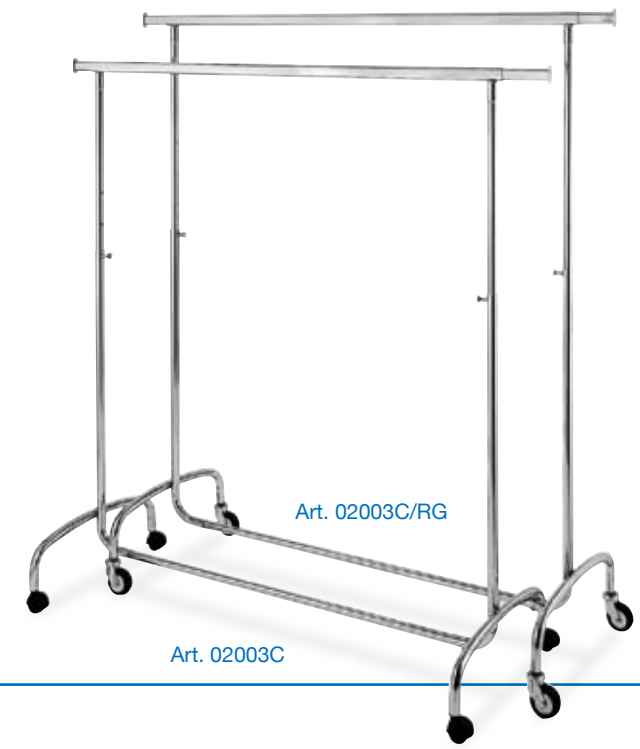

Art. 02003C/RG

Art. 02003C



Art. 02056C/RG



Art. 02067C



Art. 02521C



Art. 02530C



Art. 02502C



# STÄNDER

## Serie



Art. 02720C



Art. 02740C



Art. 02723C

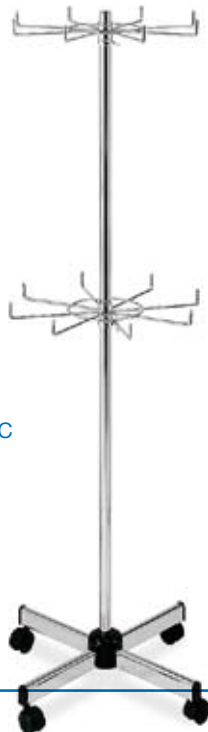

Art. 03062C



Art. 03127C



Art. 03132C



Art. 03080C



Art. 03192C



Art. 04040C



Art. 04060X



Art. 04054C

STÄNDER

Serie



Falkenweg 11b, CH-6340 Baar  
Telefon 041 768 00 50, Telefax 041 768 00 53  
[www.prochema.ch](http://www.prochema.ch) - [info@prochema.ch](mailto:info@prochema.ch)